



Cerraduras para muebles y auto Furniture and auto locks







Las cerraduras para muebles y autos de Yale cuentan con una gran variedad de diseños y acabados que se adaptan perfectamente a muebles, cajones, escritorios, puertas corredizas y distintos tipos de automóviles.

Entre las características de las cerraduras se destaca el cilindro en latón gracias a su mayor durabilidad.

The furniture and auto locks from Yale comes with a wide variety of designs and finishes that adapts perfectly to furniture, drawers, desks, overlap sliding doors and different types of automobiles.

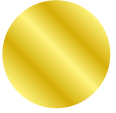
Among the features of the locks, the brass cylinder stands out given to its durability.

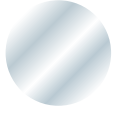
Glosario Glossary

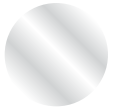
Características / Features:	Acabados / Finishes:	Abreviatura / Abbreviation:
 Fácil instalación Easy to install	 US3 Latón brillante Bright brass	C: Caja / Box
 4 pines 4 pins	 US14 Níquel brillante Bright nickel	Izq: Izquierda / Left Handed
 5 pines 5 pins	 US26 Cromo brillante Bright chrome	Der: Derecha / Right Handed
		A: Una unidad / One unit
		A2: Igualado X2 / Key alike X2
		A3: Igualado X3 / Key alike X3

Serie F6700

- Cerrojo de acero de acción vertical
- 4 pines
- Para cajones, muebles y escritorios
- 2 llaves

F6700 series

- Steel bolt upright action
- 4 pin
- For drawers, furniture and desks
- 2 keys

SKU	DESCRIPCIÓN / DESCRIPTION
0005012	Mueble F6700 US14 C

MEDIDAS EN mm. / MEASURES IN mm.			
A	B	C	D
25,6	13	25,4	16

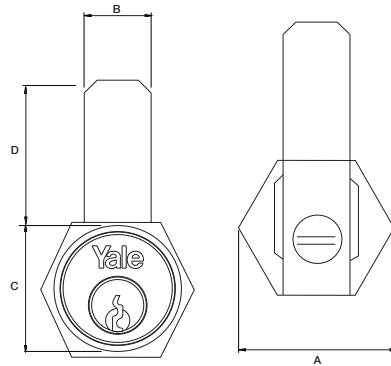

Serie 495-25

- Cerrojo de acero de acción vertical
- 5 pines
- Para cajones, muebles y escritorios
- 2 llaves referencia "A"
- 3 llaves referencias "A2" y "A3"

495-25 series

- Steel bolt upright action
- 5 pin
- For drawers, furniture and desks
- 2 keys for "A" reference
- 3 keys for "A2" and "A3" references

SKU	DESCRIPCIÓN / DESCRIPTION
0005024	Mueble 495 25A US14 C
0005025	Mueble 495 25A2 US14 C
0005026	Mueble 495 25A3 US14 C

MEDIDAS EN mm. / MEASURES IN mm.			
A	B	C	D
25,6	13	31,7	16,5

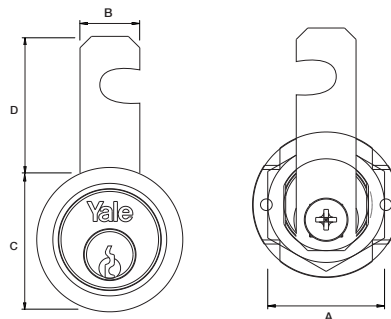



MEDIDAS EN mm. / MEASURES IN mm.						
A	B	C	D	E	F	G
45	38	20	18	27/40	22	13

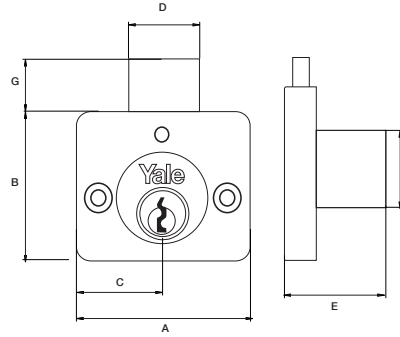

Serie 2044

- El pestillo se acciona con la llave
- 4 pines
- Pestillo vertical
- Longitud del cilindro: 27 o 40 mm según referencia
- Backset 20 mm
- Para armarios y/o escritorios
- C cuerpo zincado

2044 series

- The latch is actuated by the key
- 4 pins
- Vertical latch
- Cylinder length: 27 or 40 mm depending on reference
- Backset 20 mm
- For lockers and / or desks
- Zinc plated body

SKU	DESCRIPCIÓN / DESCRIPTION
0005007	Mueble 2044 corta US14 C
0005009	Mueble 2044 larga US14 C



MEDIDAS EN mm. / MEASURES IN mm.					
A	B	C	D	E	F
30	45	20	18	27/40	22

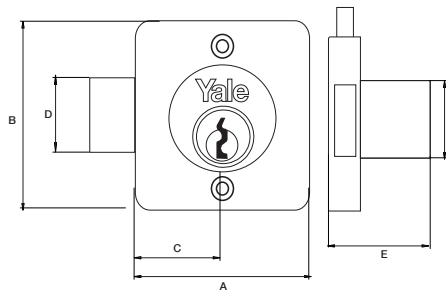

Serie 2045

- El pestillo se acciona con la llave
- 4 pines
- Pestillo horizontal
- Longitud del cilindro: 27 o 40 mm según referencia
- Backset 20 mm
- Para armarios y/o escritorios
- Cuerpo zincado

2045 series

- The latch is actuated by the key
- 4 pin
- Horizontal latch
- Cylinder length: 27 or 40 mm depending on reference
- Backset 20 mm
- For lockers and / or desks
- Zinc plated body

SKU	DESCRIPCIÓN / DESCRIPTION
0005008	Mueble 2045 corta US14 C
0005010	Mueble 2045 larga US14 C

Serie 500

- Cerrojo de acero de acción vertical
- 4 pines
- Para cajones, muebles y escritorios
- 2 llaves

MEDIDAS EN mm. / MEASURES IN mm.					
A	B	C	D	E	F
19,3	7,6	37	36	26,2	22,2

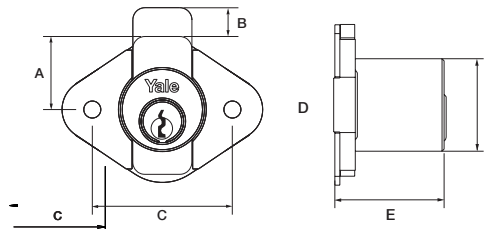

500 series

- Steel deadbolt lock
- 4 pin
- For drawers, furniture and desks
- 2 keys

SKU	DESCRIPCIÓN / DESCRIPTION
0005150	Mueble 500 US26D C

Serie 510

- Cerrojo tipo botón, cierra al presionar
- 4 pines
- Para puertas corredizas de traslape
- Para bastones antirrobo para automóvil
- Para muebles metálicos y de madera
- 2 llaves

MEDIDAS EN mm. / MEASURES IN mm.				
A	B	C	D	E
41,0	22,2	22,0	23,0	33,2

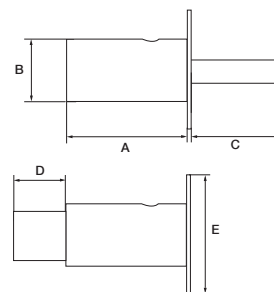

510 series

- Deadbolt lock with button
- 4 pins to prevent picking
- For overlap sliding doors
- For steering wheel locks
- Metal and wooden furniture
- 2 keys

SKU	DESCRIPCIÓN / DESCRIPTION
0001560	Mueble 510 US26D C



MEDIDAS EN mm. / MEASURES IN mm.				
A	B	C	D	E
23,7	9,2	55,7	22,2	16,3

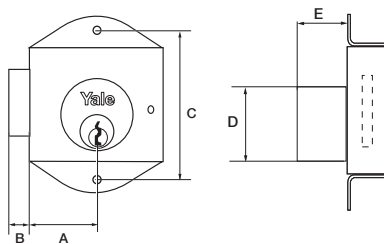

Serie 520

- Cerrojo de acción horizontal
- 4 pines
- Cilindro en latón
- 2 llaves

520 series

- Steel bolt lock
- 4 pin
- Brass cylinder
- 2 keys

SKU	DESCRIPCIÓN / DESCRIPTION
0010595	Mueble 520 US26D C



MEDIDAS EN mm. / MEASURES IN mm.							
A	B	C	D	E	F	G	H
20,0	13,0	3,2	25,4	44,5	14,4	9,0	3,5

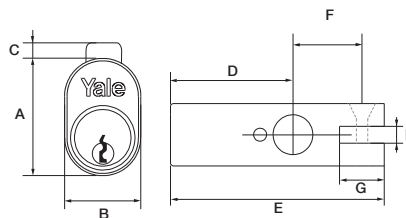

Serie 530

- Para muebles de oficina
- 4 pines
- Cilindro en latón
- 2 llaves

530 series

- For office furniture
- 4 pin
- Brass cylinder
- 2 keys

SKU	DESCRIPCIÓN / DESCRIPTION
0010594	Mueble 530 US26D C

Serie 540

- Cerrojo de gancho para puertas corredizas
- 4 pines
- Cilindro en latón
- 2 llaves

MEDIDAS EN mm. / MEASURES IN mm.					
A	B	C	D	E	F
20,2	16,3	33,0	49,6	22,2	23,9

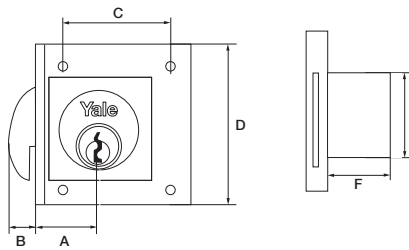

540 series

- Deadbolt lock for sliding doors
- 4 pin
- Brass cylinder
- 2 llaves

SKU	DESCRIPCIÓN / DESCRIPTION
0010591	Mueble 540 US26D Izq C
0010589	Mueble 540 US26D Der C

Serie 555B

- Cuerpo hecho de latón
- 4 pines
- Backset 20mm
- Para armarios y muebles
- 2 llaves

MEDIDAS EN mm. / MEASURES IN mm.				
A	B	C	D	E
51,0	38,0	21,4	23,4	22,1

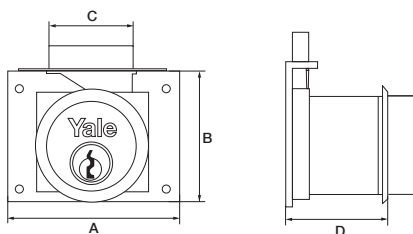

555B series

- Brass plated body
- 4 pin
- 20mm backset.
- For cabinets and furniture
- 2 keys

SKU	DESCRIPCIÓN / DESCRIPTION
0005151	Mueble 555B US3 C



MEDIDAS EN mm. / MEASURES IN mm.				
A	B	C	D	E
121,7	32,8	111,6	26,3	23,6

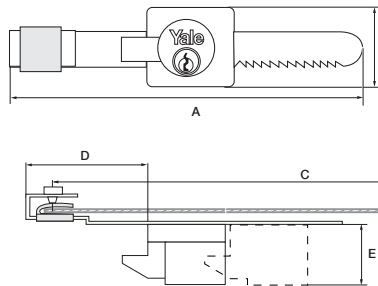

Serie 560

- Para vitrinas y puertas corredizas
- 4 pines
- Cobertura en caucho antideslizante
- 2 llaves

560 series

- For glass cabinets and sliding doors
- 4 pins
- Anti-sliding rubber coverage
- 2 keys

SKU	DESCRIPCIÓN / DESCRIPTION
0001574	Mueble 560 US26D C